



瑞得仪器

20系列 | ELECTRONIC TOTAL STATION

瑞得全站仪RTS-

# 操作手册

OPERATION  
MANUAL

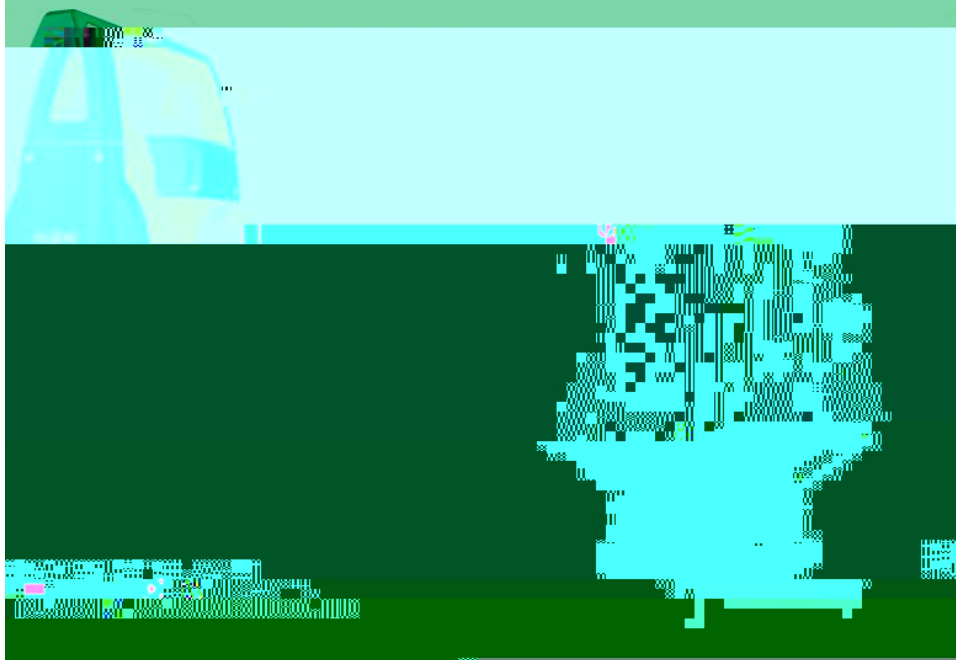



.....	5
.....	5
.....	7
.....	10
.....	10
.....	11
.....	12
.....	12
.....	14
.....	16
.....	16
.....	17
.....	17
.....	19
.....	19
.....	19
.....	20
.....	20

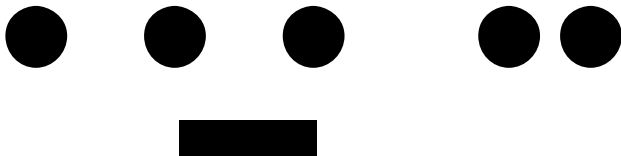

.....	26
.....	26
.....	28
.....	28
.....	28
.....	29
.....	29
.....	29
.....	30
.....	32
.....	32
.....	33
.....	34
.....	36
.....	37
.....	38
.....	38
.....	38
.....	39
.....	39
.....	40
.....	41
.....	41
.....	41
.....	42
.....	42
.....	42
.....	43
.....	43
.....	43
.....	43
.....	45

.....	46
.....	46
.....	48
.....	48
.....	48
.....	51
.....	53
.....	55
.....	55
.....	57
.....	58
.....	58

.....	76
.....	77
.....	79
.....	81
.....	81
.....	82
.....	82
.....	83
.....	84
¼ 4à _ ‡— °yñq €Ñáp	85
Ö	85
.....	86
.....	86
.....	87
ñr ñ0 WYY9 »	87
.....	88
.....	91
.....	94
"dãÑÑD ^?P	% Đ ¼R
.....	96
13.2 »	.....

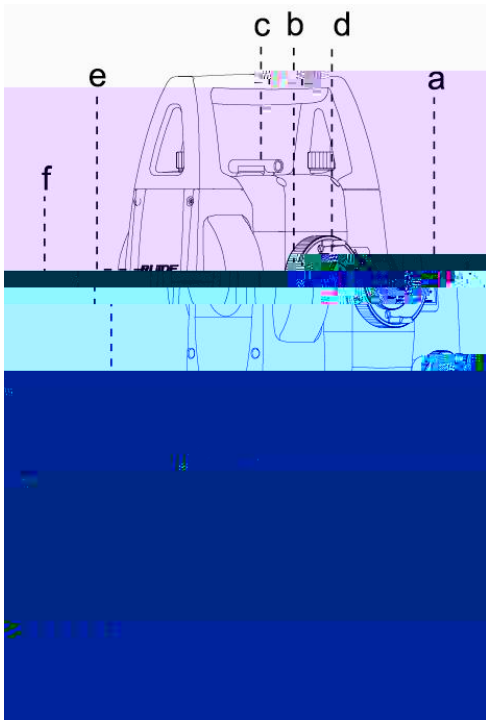

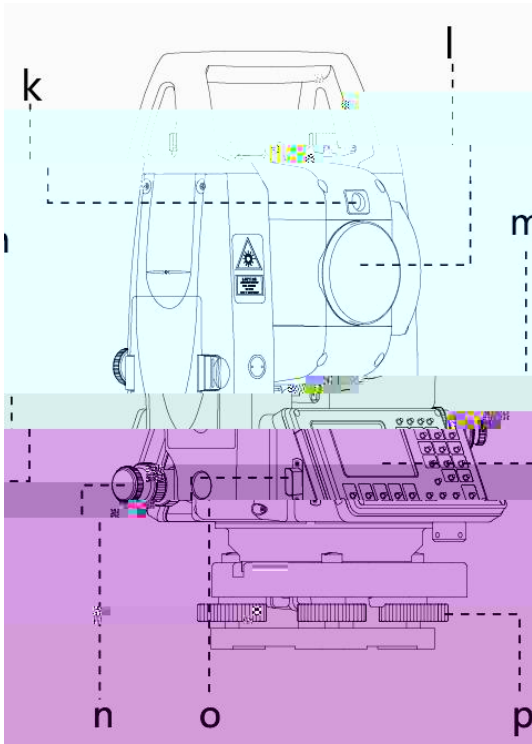

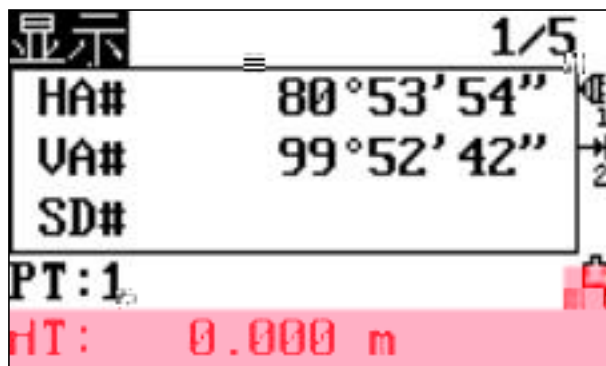
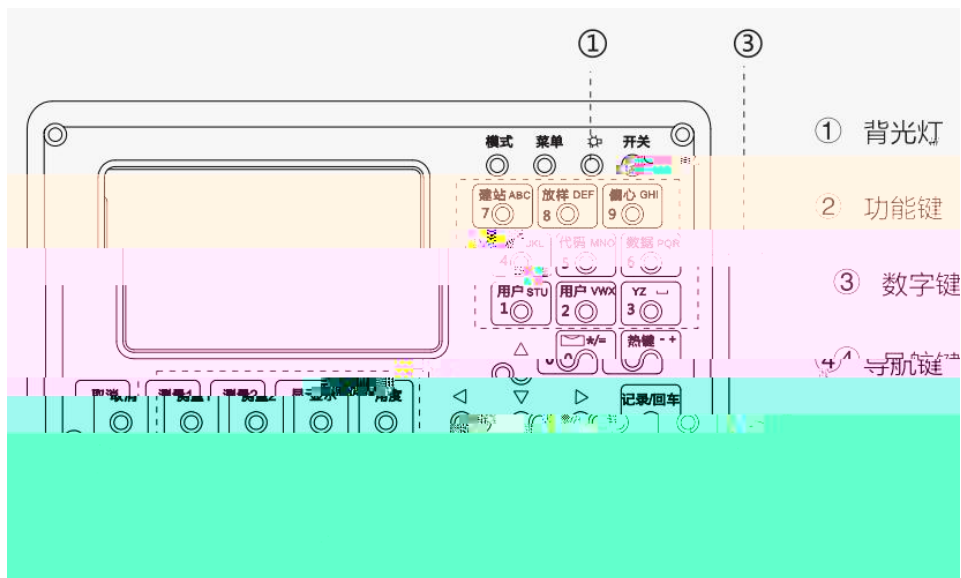



偏心 GHI  
9 ●

程序 JKL  
4

代码 M  
5 ●





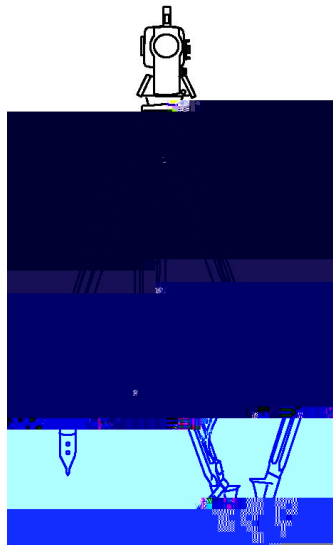
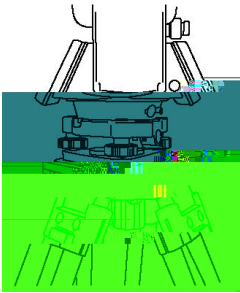

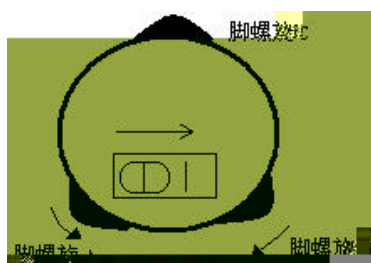
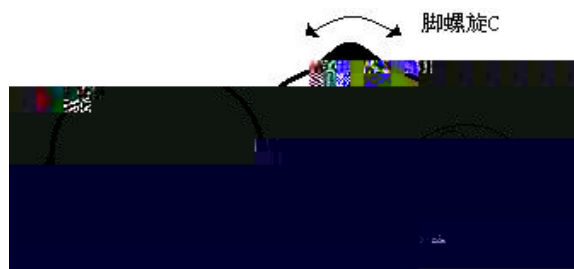

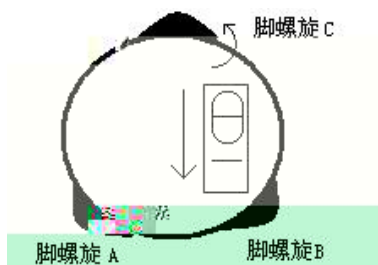

显示	1/5
HA#	80°53'54"
VA#	99°52'42"
SD#	
PT:1	
HT:	0.000 m

↓ ↓ ↓ ↓ ↓ ↓ ↓ ↓

} 可进行测量

↓

↓ 电池电量不多，应当对电池

↓ 充电或更换电池，再进行测量，

↓ 必须充电或 更换电池



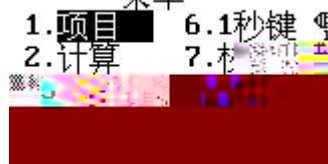

-----菜单-----

- |       |        |
|-------|--------|
| 1. 项目 | 6. 1秒键 |
| 2. 计算 | 7. 棱镜  |
- 

-----设置-----

- |        |        |
|--------|--------|
| 1. 角度  | 6. 放样  |
| 2. 距离  | 7. 单位  |
| 3. 坐标  | 8. 记录  |
| 4. 电源  | 9. 其他  |
| 5. PPM | 10. 蓝牙 |
- 

<角度>

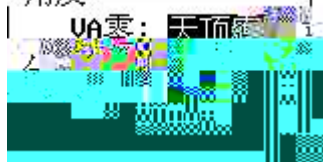

<距离>



<坐标>

顺序: **NEZ**

标记: **NEZ**

AZ零: 北

<电源>

主机关闭: **30分钟**

EDM关闭:

温度、气压

温度: **20.0 C**

气压: **1013.2 hPa**

ppm= **0.0**

开 关

<放样>

增加点: **0**

<单位>

角度: **度**

距离: **米**

温度: **C**

气压: **hPa**



指标差校准

X : -0°00' 14"  
UA: 51°56' 49"

确认

指标差校准

X : -0°00' 13"  
UA: 51°56' 49"

\*请转向F2

确认

用棱镜仪器加常数

: 0.0 mm

不用棱镜仪器加常数

: 0.0 mm



<日期>

日期:2019.09.19

时间:13:48:01

2019-09-19 13:48:17

型号:RTS-284X

机身号:1111111

日期:19.09.19

MAIN: 001-19.09.06

EDM : 234-116

ANG : 040-002

TILT: 107-004

T&P : 101-108





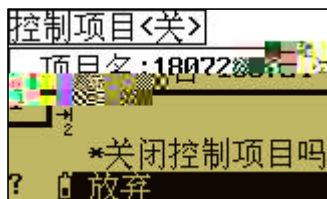
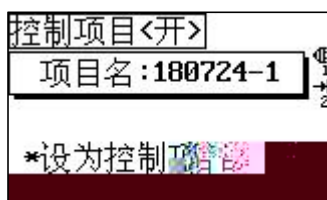



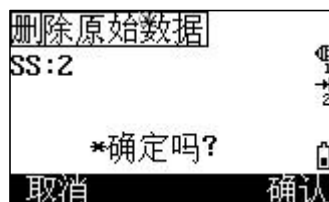

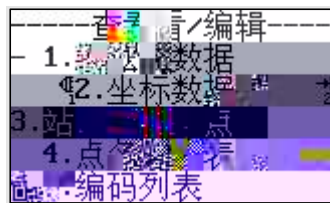
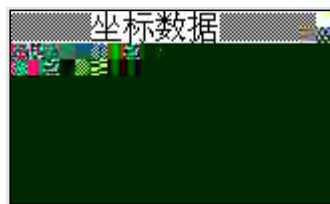

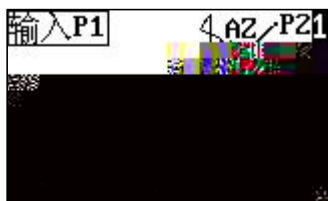
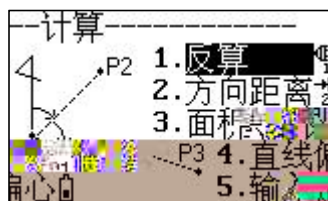





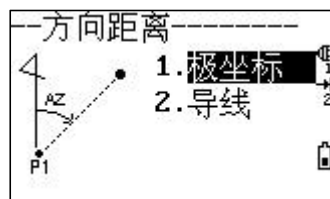

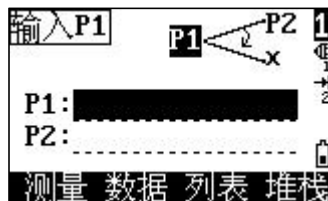
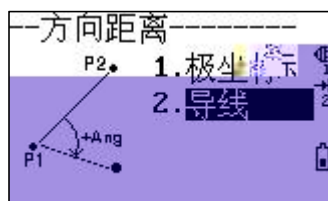
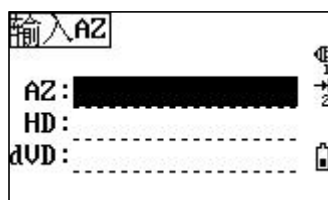

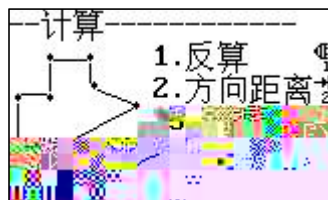
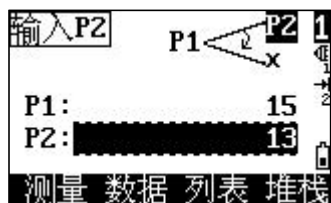
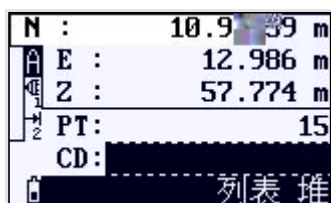
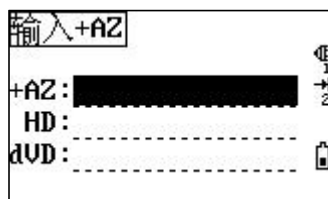









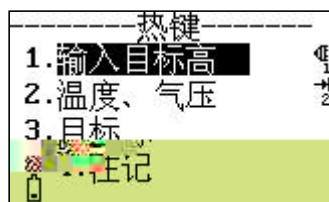

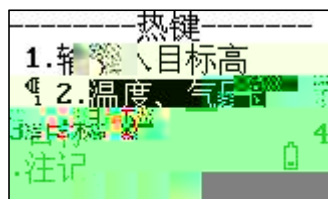

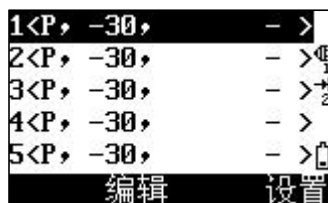

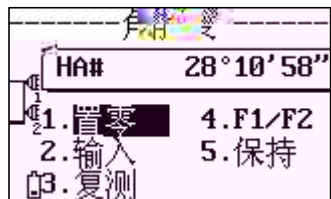
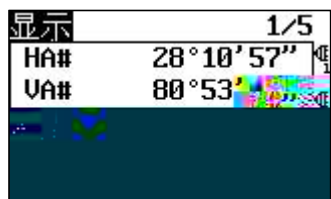
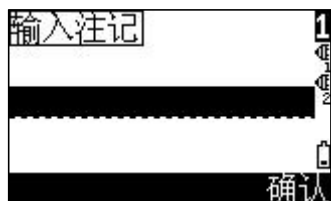

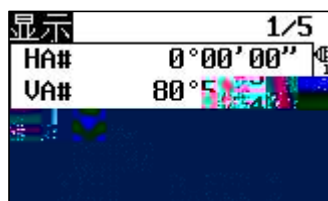

$$\bar{X} = \sum_{i=1}^N x_i$$

$$A_z = \bar{X}$$

$$\bar{X}$$

$$\Sigma$$

复测	N=04
HRE	119°58'

复测	N=04
HRx	30°00'01" →
HA#	30°00'05" ←
HD#	5.698 m
*按[回车]记录	
FS点作为控制点记录	

!	F1/F2观测
dHA:	-179°59'57" ←
dVA:	105°34'51" ←
dSD:	
放弃	CP 确认

शुद्ध

शुद्ध



建站ABC  
7 ●

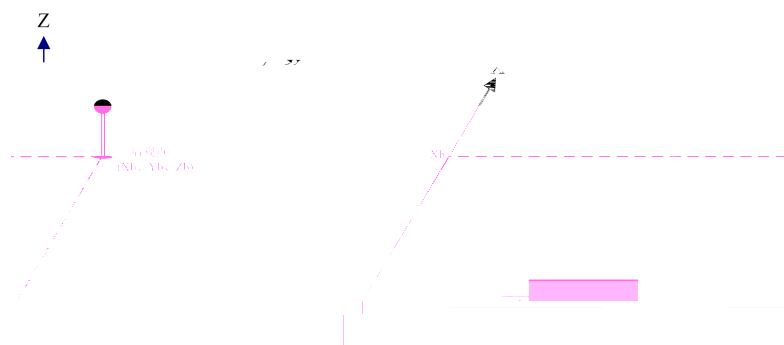

输入站	1
ST: [REDACTED]	1
HI: 1.200 m	2
CD:	
列表 堆栈	

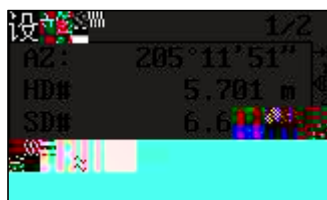

@



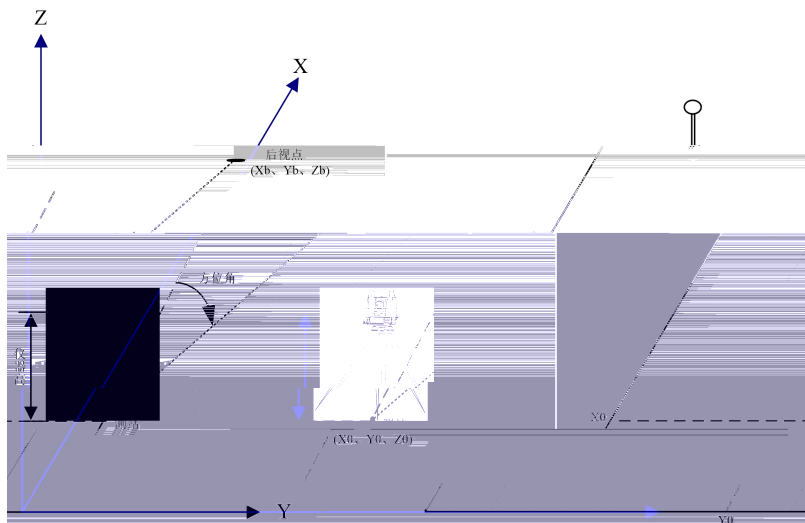

输入后视角度

AZ: 

→  
1  
2





后交 <照准点01>  
HA# 12°43'53"  
HD# 6.001 m  
SD# 0.507 m  
按[回车]到下一点  
F2



输入PT		1
PT:	[REDACTED]	1
HT:	1.500 m	2
CP:	[REDACTED]	
列表 堆		

水准点		
HA#	359°22'55"	1
VD#		2
HD#		
*照准点按 [F5] 键		
F		

设置		
HA:	-179°59'59"	1
VA:	83°35'48"	2
ASD:	0.076 m	
*按 [回车] 记录		
放弃 CP 确认		

N :	0.000 m	1
E :	0.000 m	2
Z :	1.308 m	
ST:657		
HI :	1.200 m	

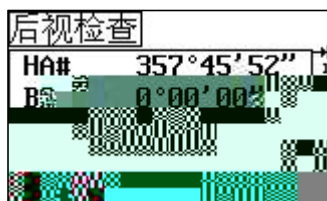





显示	1/5
HA#	269°50'30"
VA#	336°51'19"
SD#	
PT:4	
HT:	1.500 m

PT:	
HT:	1.500 m
CD:	
列表 推	

2棱镜杆 <第1点> 1/5	
HA#	268°15'22"
VA#	336°51'19"
SD#	
*照准点按[测量]键	
确认	

输入距离	
P1-P2	: 5.000 m
P2-目标	: 5.000 m
=P1-P2可以省略	



HA: 207°56'26"  
VA 313°18'32"  
SD: 0 m  
PT: 5  
CD:   
列表堆

输入平距  
HA# 273°03'32"  
VA# 313°09'50"  
HD: 0.000 m  
\*照准点按[回车]

PT:   
HT: 1.500 m  
CD:   
列表堆

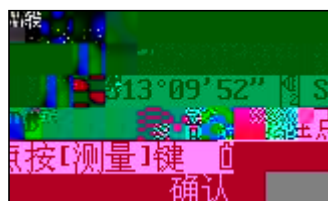

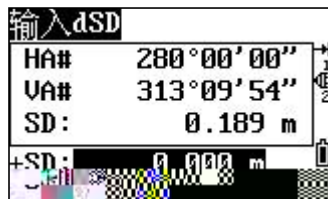
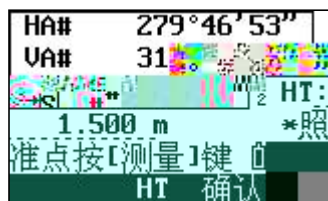

程序JKL  
4

平面图:

纵面图:

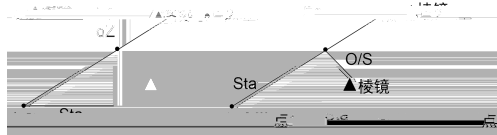

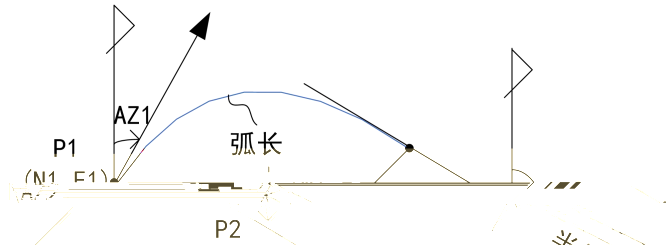

**曲线起始点**

P1: [REDACTED]

AZ1: [REDACTED]

测量 列表 堆棧

**定义曲线**

1. P2-AZ2

2. 半径-AZ2

**参考圆弧**

Rad: 0.275 m

Len: 0.240 m

AZ2: [REDACTED]



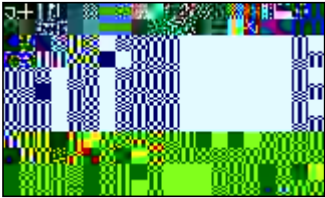
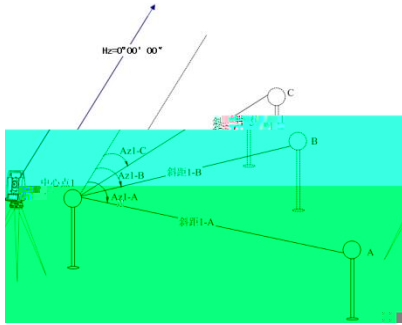

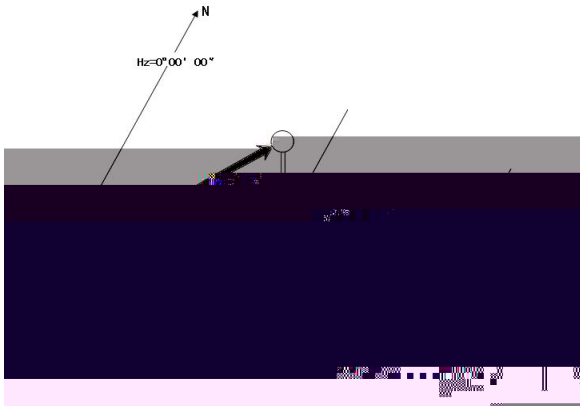
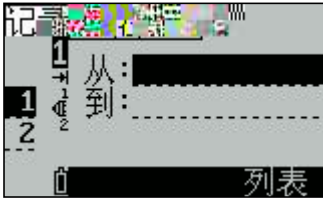

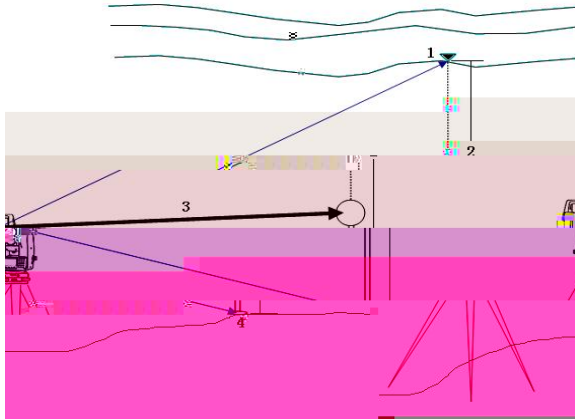

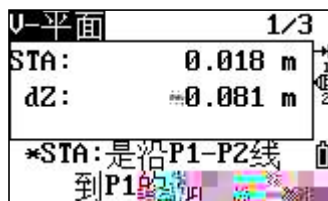
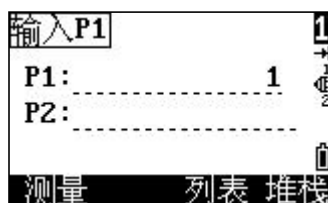
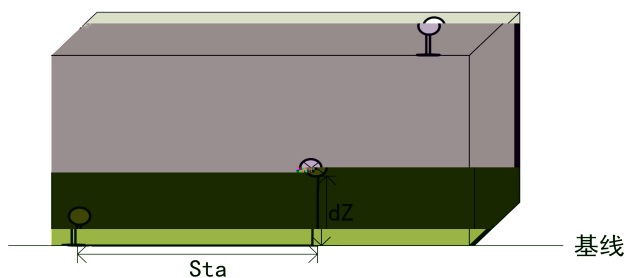
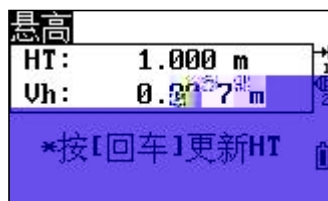



<b>输入P1</b>		<b>1</b>
P1:	████████████████████	→ 1
P2:	-----	← 2
P3:	-----	↑
测量 列表 堆栈		

<b>输入P3</b>		<b>1</b>
P1:	----- 29	→ 1
P2:	----- 30	← 2
P3:	████████████████████	↑
测量 2点 列表 堆栈		

S-平面		1/3
a:	-0.018 m	1
b:	-0.094 m	2



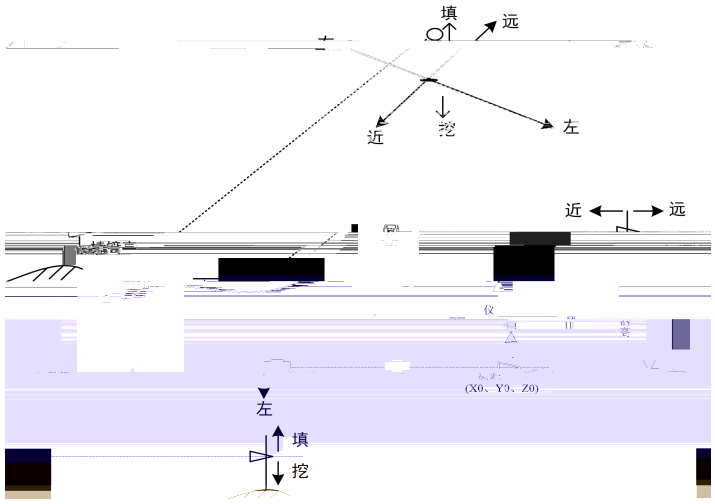

放样 DEF  
8 ●

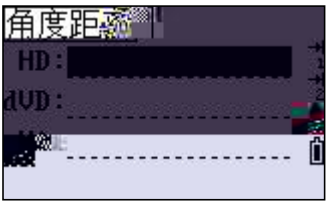



输入PT 1

PT: XXXXXXXXXX 1

Rad: XXXXXXXXXX 2

CD: XXXXXXXXXX 3

从/到 列表 堆栈

N :            -0.153 1

E :             1.374 2

Z :             3.503 3

PT:101 4

CD: 5

PT:101 1

dAZ←        0°00'02" 2

HD#        2.150 m 3

\*照 4

准点按[测量]键 5

确认 6

PT:101 1/8

dHA↑        0°00'01" 1

停 ↑        0.000 m 2

远 ↑        0.002 m 3

填 ↑        0.001 m 4

\*按[回车]记录 5

<b>PT:101</b>		<b>1/8</b>
dHA	↑	0°00'00"
停	↑	0.000 m
停	↓	0.001 m
停	↓	0.001 m
*按[回车]记录		

<b>N :</b>	<b>-0.153 m</b>	<b>1</b>
<b>E :</b>	<b>1.375 m</b>	
<b>Z :</b>	<b>3.503 m</b>	
<b>PT :</b>	<b>106</b>	
<b>CD :</b>		
列表 堆栈		

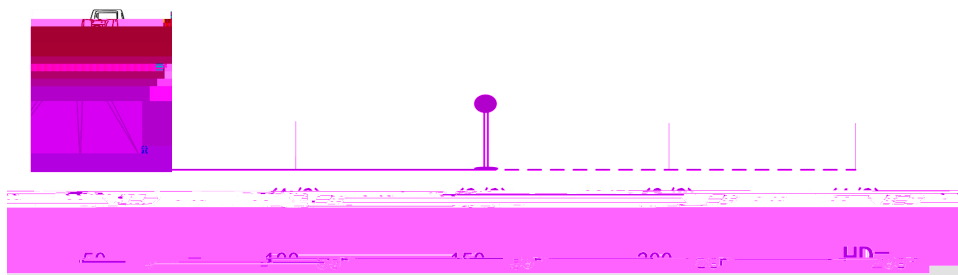

N : -1.375  
 E : 0.152 m  
 Z : 1.96

输入P1  
 P1: [REDACTED]  
 P2: \_\_\_\_\_  
 测量 列表 堆栈

输入偏心  
 STA: [REDACTED]  
 O/S: \_\_\_\_\_  
 dZ: \_\_\_\_\_  
 \*到P1点的纵向距离

参考线  
 dAZ← 168°20'50"  
 HD# 0.783 m  
 \*照准点按[测量]键  
 确认

参考线	1/8
dHA←	169°54'40"
右 ←	0.137 m
近 ↓	1
	0.267 m

N :	-0.090 m
E :	-0.610 m
Z :	2.025 m
PT:	8
CD:	

列表 堆栈

道路

1. **水平定线数据**
2. 垂直定线数据
3. 建站
4. 道路放样

起始点 01

桩号: 0.000

N : 0.000 m

E : 0.000 m

输入水平定线 01

桩号: 1.000 m

方位角: 0°00'00"

直线 圆弧 缓曲 交点



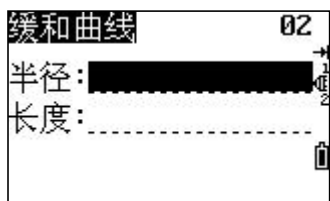
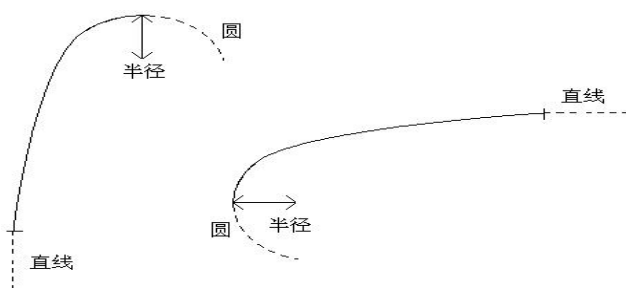

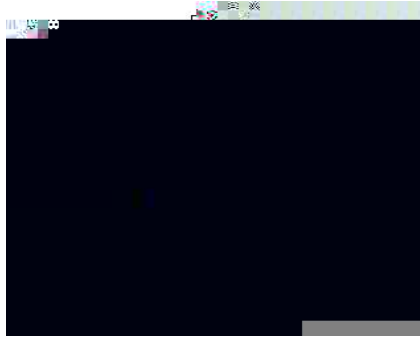



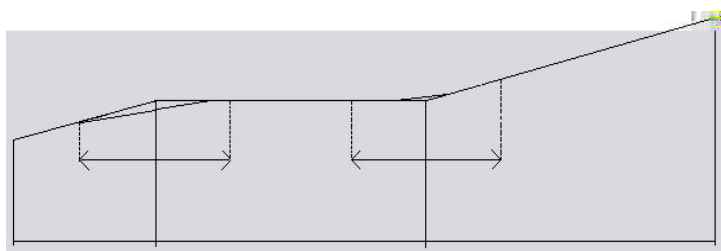
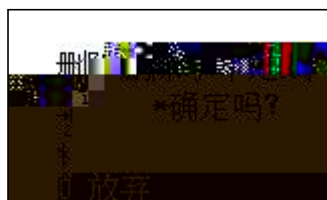

输入垂直定线	06
桩号:	0.000
高程:	0.000 m
长度:	0.000 m

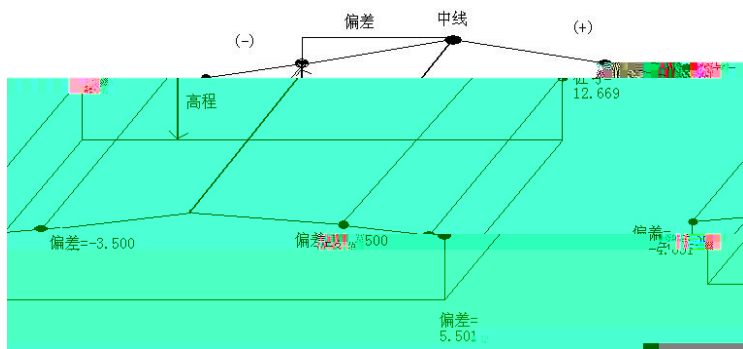



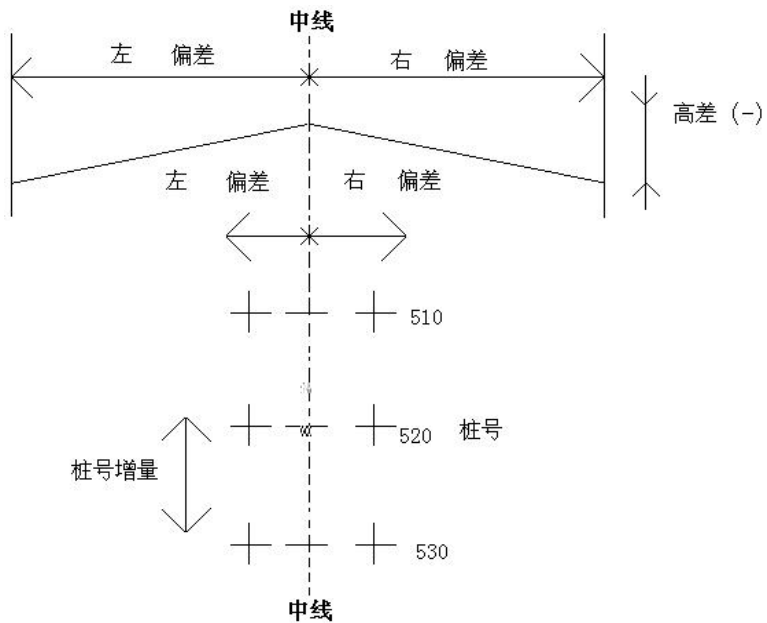





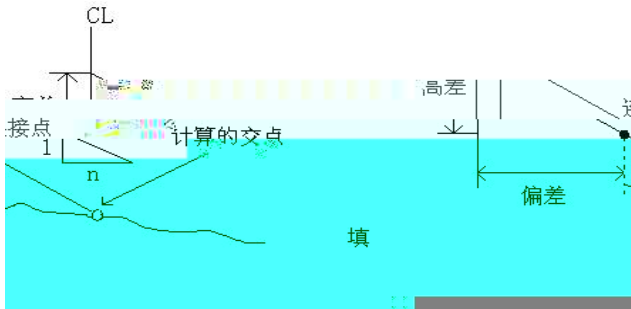
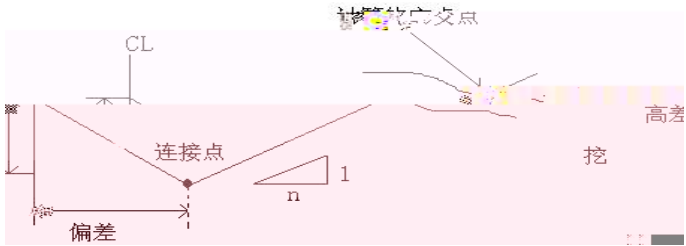
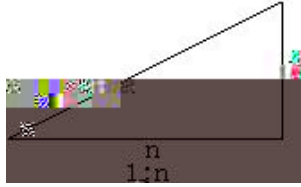

斜坡放样  
( 1:N )

左	挖	:	0.000
左	填	:	0.000
右	挖	:	0.000
右	填	:	0.000

请选择

左	挖	:	4.0
左	填	:	2.0
右	挖	:	2.0
右	填	:	2.0

.000 左右

斜坡放样

斜坡放样

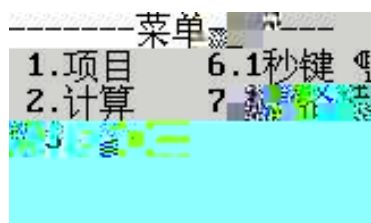

-----设置-----

- |        |        |   |
|--------|--------|---|
| 1. 角度  | 6. 放样  | 1 |
| 2. 距离  | 7. 单位  | 2 |
| 3. 坐标  | 8. 记录  | 3 |
| 4. 电源  | 9. 其他  | 4 |
| 5. PPM | 10. 蓝牙 | 5 |

<记录>

存储方式:所有的  
数据记录:蓝牙

显示

1/5

HA#	8°00'56"	1
VA#	62°50'08"	2
SD#		3

PT:0.000+0.001  
HT: 1.500 m 蓝牙





---





---





---





ΚΕΚΕΤ/Β)·b ·8-+ΔΜΑΥΘ

Λ

b

CE

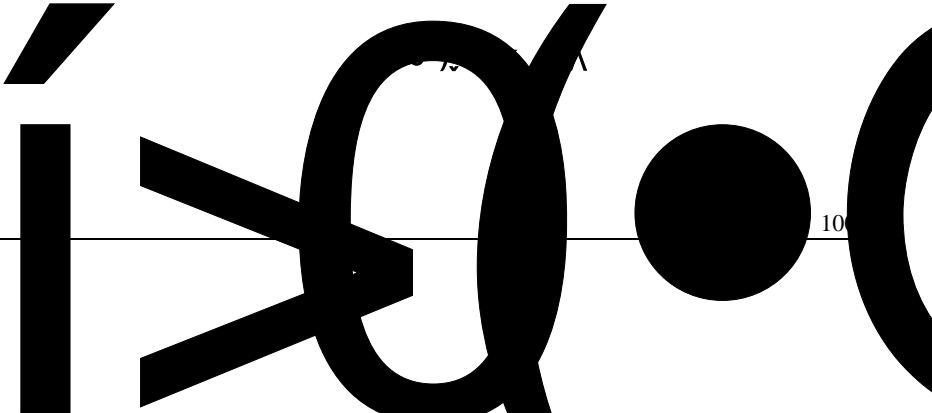
80428085 (180) 1708301



---

---

: RTS-822

---

---

---





---











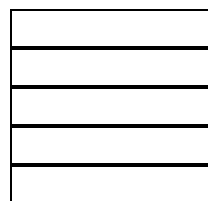
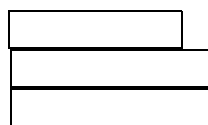
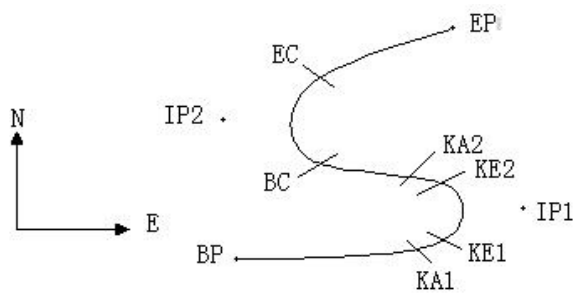

---





-----



$\Delta$

$$\Delta = - (1 - \cos \tau)$$

$$\Delta = 6.777 - 100(1 - \cos 18$$

=

$$\Delta_1 = \Delta_2$$

$$= - \sin \tau$$

$$1 = 2$$

$$1 \quad \text{---} \quad 2 \quad \text{co} \quad ) \quad 1$$



-----

---

$$\Rightarrow \alpha_1 =$$

$$_1 =$$

---

$$= \cdot \tan\left(\frac{\quad}{2}\right) =$$

$$= \quad \cdot \cos \alpha_2$$

$$= \quad \cdot \sin \alpha_2$$

$$= \quad \cdot \cos \alpha_3$$

$$= \quad \cdot \sin \alpha_3$$

$\alpha_2$

$\alpha_3$

=

=

=

=

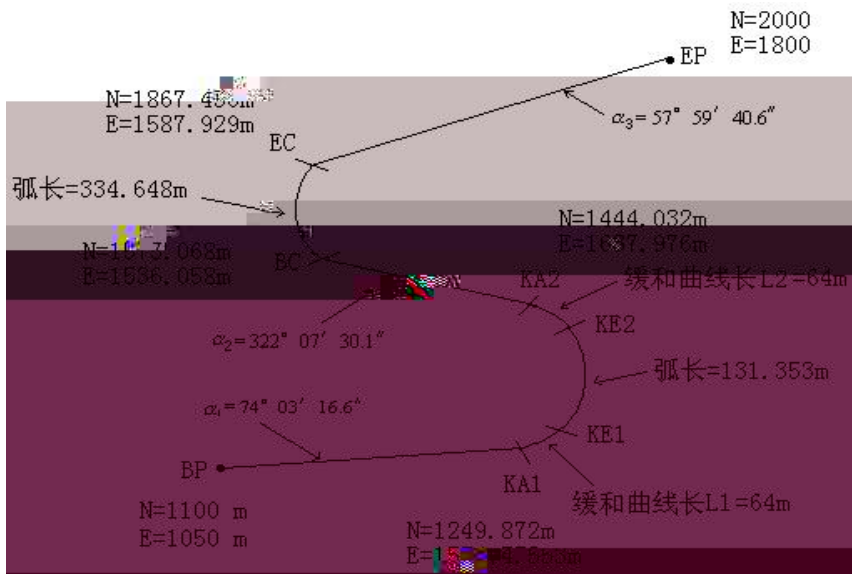

$$\sqrt{(1249.872-1100.000)^2 + (1574.553-1050)^2} = 545.543$$

$$= \sqrt{(1575.068-1444.032)^2 + (1536.058-1637.976)^2} = 166.005$$

$$\sqrt{(2000 - 1867.456)^2 + (1800 - 1587.929)^2} = 250.084$$



